

UNITED STATES NAVAL OBSERVATORY

CIRCULAR NO. 141

U.S. Naval Observatory, Washington, D. C. 20392

March 16, 1973

LUNAR LIMB PROFILES FOR SOLAR ECLIPSES

by

Julena S. Duncombe

Note to Electronic Edition

In the printed edition of this Circular, even pages 10–32 were intentionally left blank; the blank pages are not provided herein.

LUNAR LIMB PROFILES FOR SOLAR ECLIPSES

This *Circular* contains selected lunar limb profiles designed for use in solar eclipse predictions. These profiles, used in accordance with the criteria mentioned below, allow the eclipse observer to predict the effect of lunar limb irregularities on the time of second and third contacts for any site along the eclipse path. The arguments of these profiles range in topocentric longitude from $+6^\circ$ to -6° ; topocentric latitude is 0° since solar eclipses always occur near the nodes of the lunar orbit.

For an observer who is on the axis of shadow of the Moon, the topocentric librations are diametrically opposite the selenographic coordinates of the Sun at the instant of observation. The topocentric librations at any point near the central line are:

$$\begin{aligned}L &= 270^\circ - \text{Sun's selenographic colongitude} \\B &= -\text{Sun's selenographic latitude.}\end{aligned}$$

The topocentric position angle of the axis of the Moon is:

$$C = C_0 + \Delta C$$

where

C_0 = the position angle of the axis of the Moon

ΔC = the correction to the position angle to give the topocentric value

and

$$\Delta C = -\pi' \sin Q \tan \delta \cong -1.0 \sin z \sin Q \tan \delta.$$

In these equations:

z = zenith distance = 90° - altitude of Sun

δ = declination of Sun

Q = parallactic angle = $P - V$

and by definition,

Q is the parallactic angle measured eastward from the north point of the disk to the vertical circle through the observer's zenith,

P is the position angle of the point of contact, measured eastward from the north point of the disk, and,

V is the position angle of the point of contact, measured eastward from the vertical circle through the observer's zenith.

Example for Total Solar Eclipse 30 June 1973 at Atar, Mauritania

The Sun's selenographic colongitude and latitude, declination, and the position angle of the axis of the Moon are given in the American Ephemeris and Nautical Almanac. The parallactic angle and altitude of the Sun are obtained from the local circumstances for the observer's location.

Circular No. 135—Total Solar Eclipse 30 June 1973, pg. 12 - 13, Local Circumstances
 Atar, Mauritania—Maximum eclipse occurs at 10^h 47^m 07^s.0, Altitude of the Sun = 60°. 10^h 47^m 07^s.0 = 10^h 7853 = 0^d.4494, the interpolating factor for the values from the A. E.

A. E., p. 27 Declination of Sun = +23°.2.

A. E., p. 373	Sun's selenographic				Position angle of
Date	longitude	Δ'	latitude	Δ'	axis of Moon
June 30	262°.95		-0°.02		359°.01
July 1	275.21	+12°.26	-0.05	-0°.03	5.41 +6°.40
$L = 270^\circ - (262^\circ.95 + 5^\circ.51) = +1^\circ.54$ $B = -(-0^\circ.02 - 0^\circ.01) = +0^\circ.03$ $C_0 = 359^\circ.01 + 2^\circ.88 = 361^\circ.89 = +1^\circ.89$					

Circular No. 135, pg. 12 - 13

Atar	2nd contact	P = 78°	V = 166°, then	Q ₂ = 272°	z = 30°
	3rd contact	P = 296°	V = 25°, then	Q ₃ = 271°	
		sin Q ₂ = -0.99939		sin z = +0.50000	
		sin Q ₃ = -0.99985		tan δ = +0.42860	

Since $\Delta C = -1^\circ.0 \sin z \sin Q \tan \delta$,
 then $\Delta C_2 = +0^\circ.21$ $\Delta C_3 = +0^\circ.21$
 and $C_2 = +1^\circ.89 + 0^\circ.21 = +2^\circ.1$ $C_3 = +1^\circ.89 + 0^\circ.21 = +2^\circ.1$

For Atar, Mauritania, either profile L = +1°.00, B = 0°.0 or profile L = +2°.00, B = 0°.0 may be used since the profiles are so similar.

The north point of the disk is 2°.1 toward the west from the "N" on the lunar profile. The "N" on the profile indicates the lunar meridian containing the north pole of the Moon's rotation, while the north point of the disk is the intersection of the hour circle through the center of the disk with the limb in the direction of the north celestial pole. The position angle of the axis is the angle subtended at the center of the disk between the hour circle and the north lunar pole, measured eastward from the hour circle.

The second and third contact points may be plotted on a circle of three inches radius using milar or any other transparent medium. This transparency may then be placed over the appropriate lunar limb profile with the "N"s aligned.

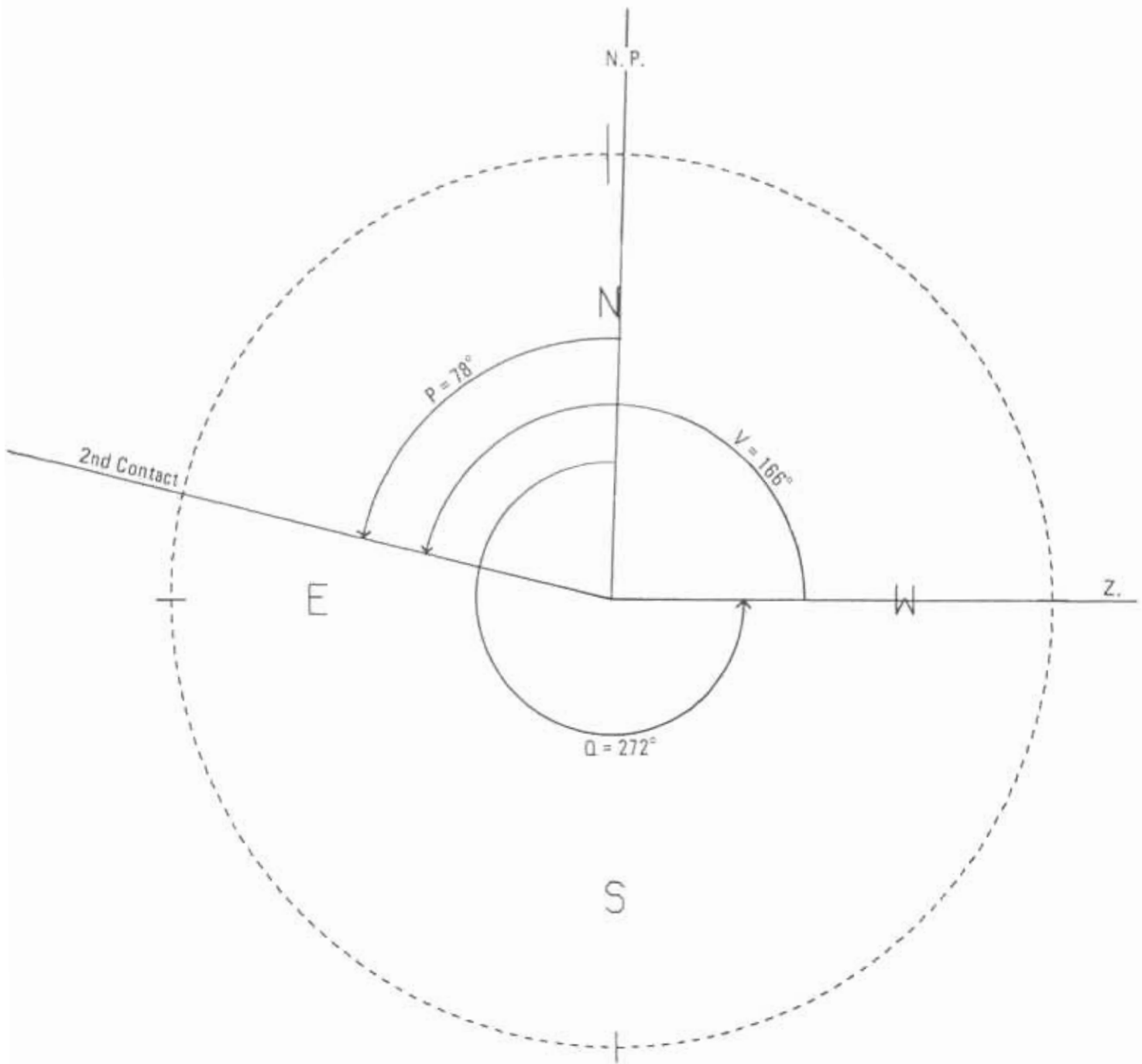

N. P. = Direction to north celestial pole
Z. = Direction to zenith

LUNAR LIMB PROFILES FOR SOLAR ECLIPSES

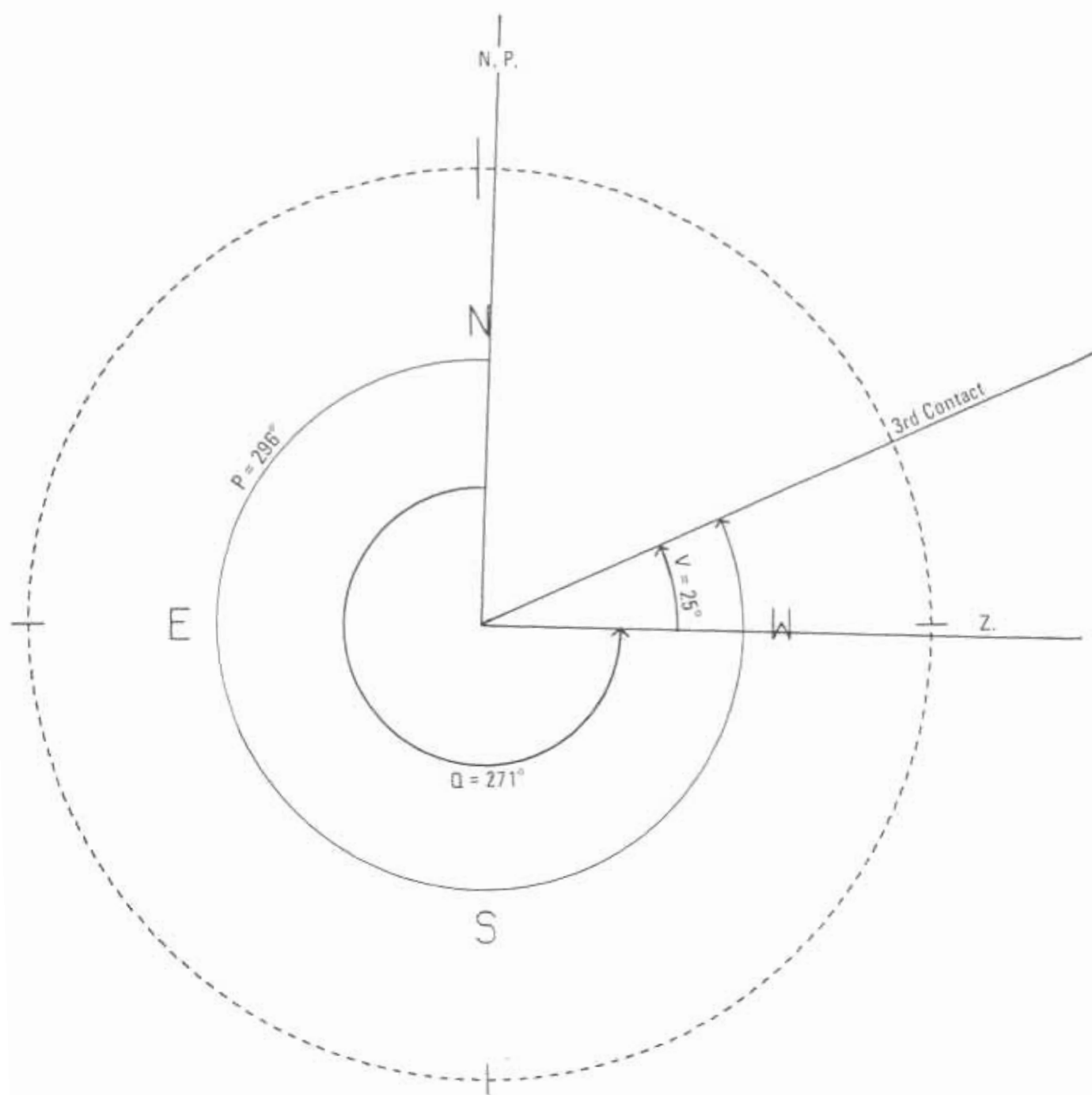

N. P. = Direction to north celestial pole
Z. = Direction to zenith

LUNAR LIMB PROFILE

L=+1°00 B=0°00

RADIAL SCALE: 1 SECOND OF ARC = 
DOTTED LINE = MEAN LIMB SOLID LINE = TRUE LIMB

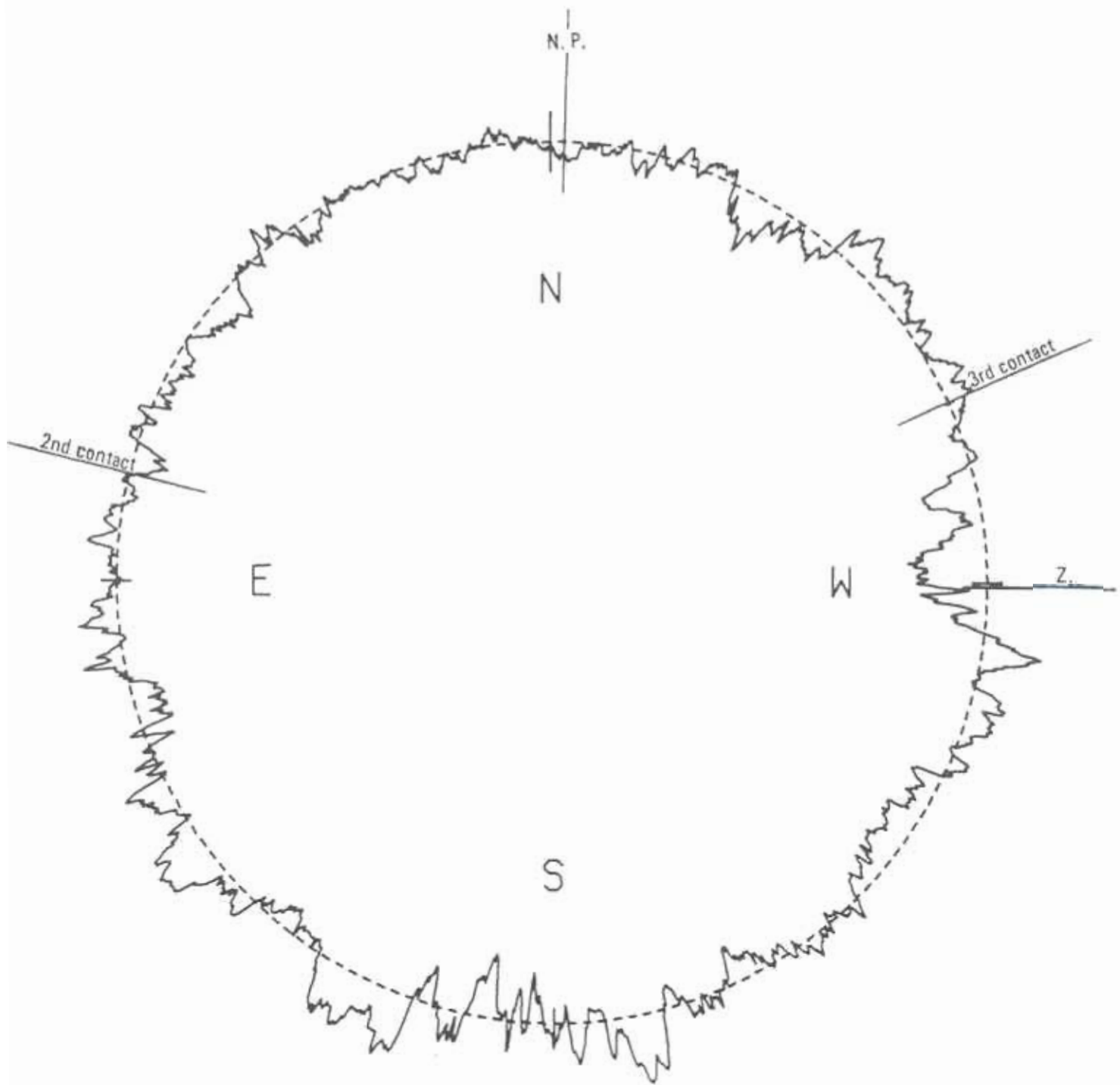

N. P. = Direction to north celestial pole
Z. = Direction to zenith

The lunar limb profiles in this *Circular* are derived from "The Marginal Zone of the Moon", Astronomical Papers prepared for the use of the American Ephemeris and Nautical Almanac, Vol. XVII, 1963 by Dr. Chester B. Watts.

The contours of the marginal zones were converted into machine readable form by H. M. Nautical Almanac Office, Royal Greenwich Observatory. These contours were then transferred to heights in a longitude-latitude grid and reorganized into a form suitable for direct access on a high speed computer by Mr. Ronald Abileah and Dr. Thomas C. Van Flandern, Nautical Almanac Office, U. S. Naval Observatory. The program to plot the profiles was written by Mr. Jeffrey Spain, Nautical Almanac Office, U. S. Naval Observatory.

LUNAR LIMB PROFILE

L=+6°00 B=0°00

RADIAL SCALE: 1 SECOND OF ARC = \longleftarrow
DOTTED LINE = MEAN LIMB SOLID LINE = TRUE LIMB

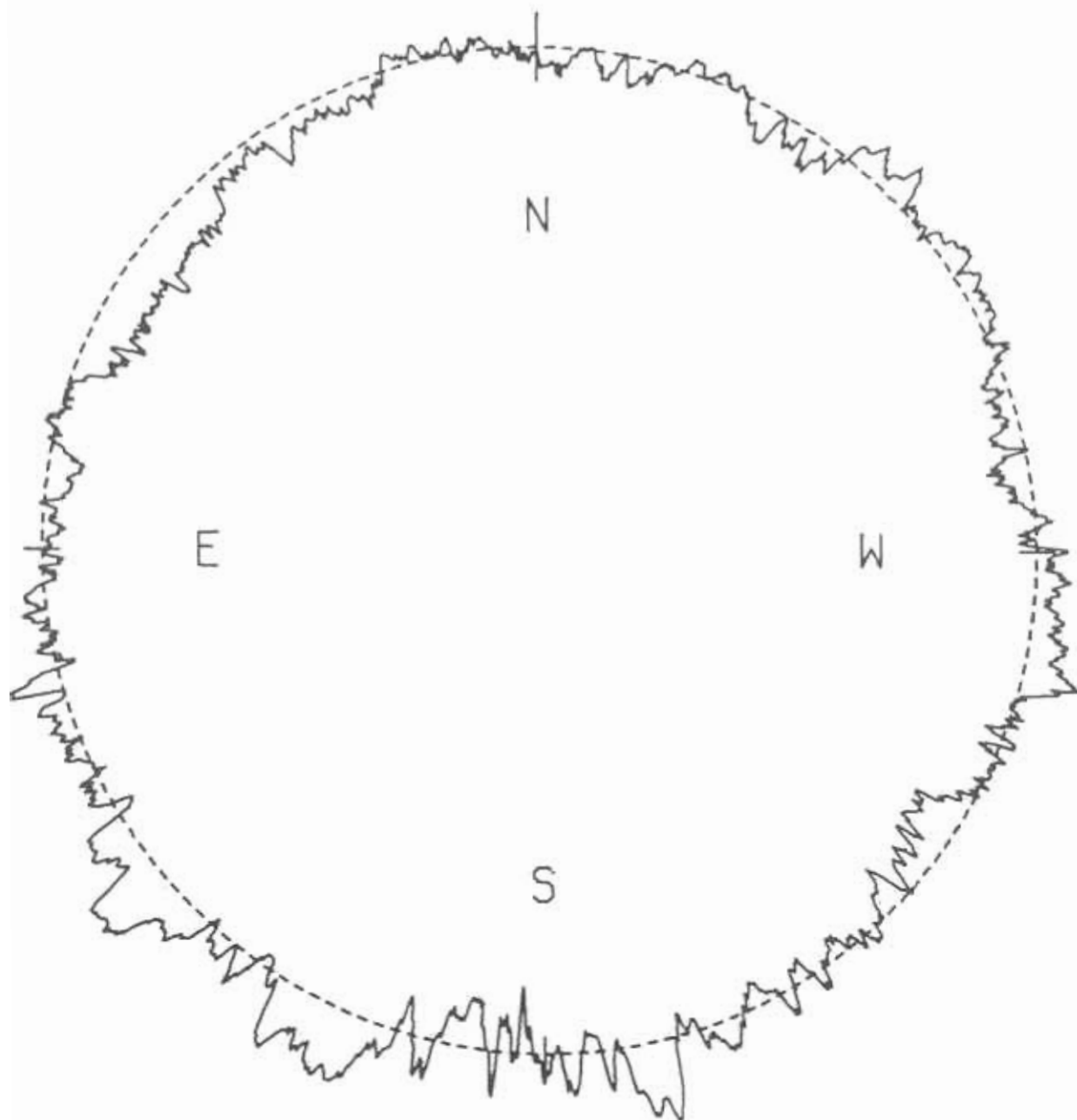

LUNAR LIMB PROFILE

11

L=+5°00 B=0°00

RADIAL SCALE: 1 SECOND OF ARC = 
DOTTED LINE = MEAN LIMB SOLID LINE = TRUE LIMB

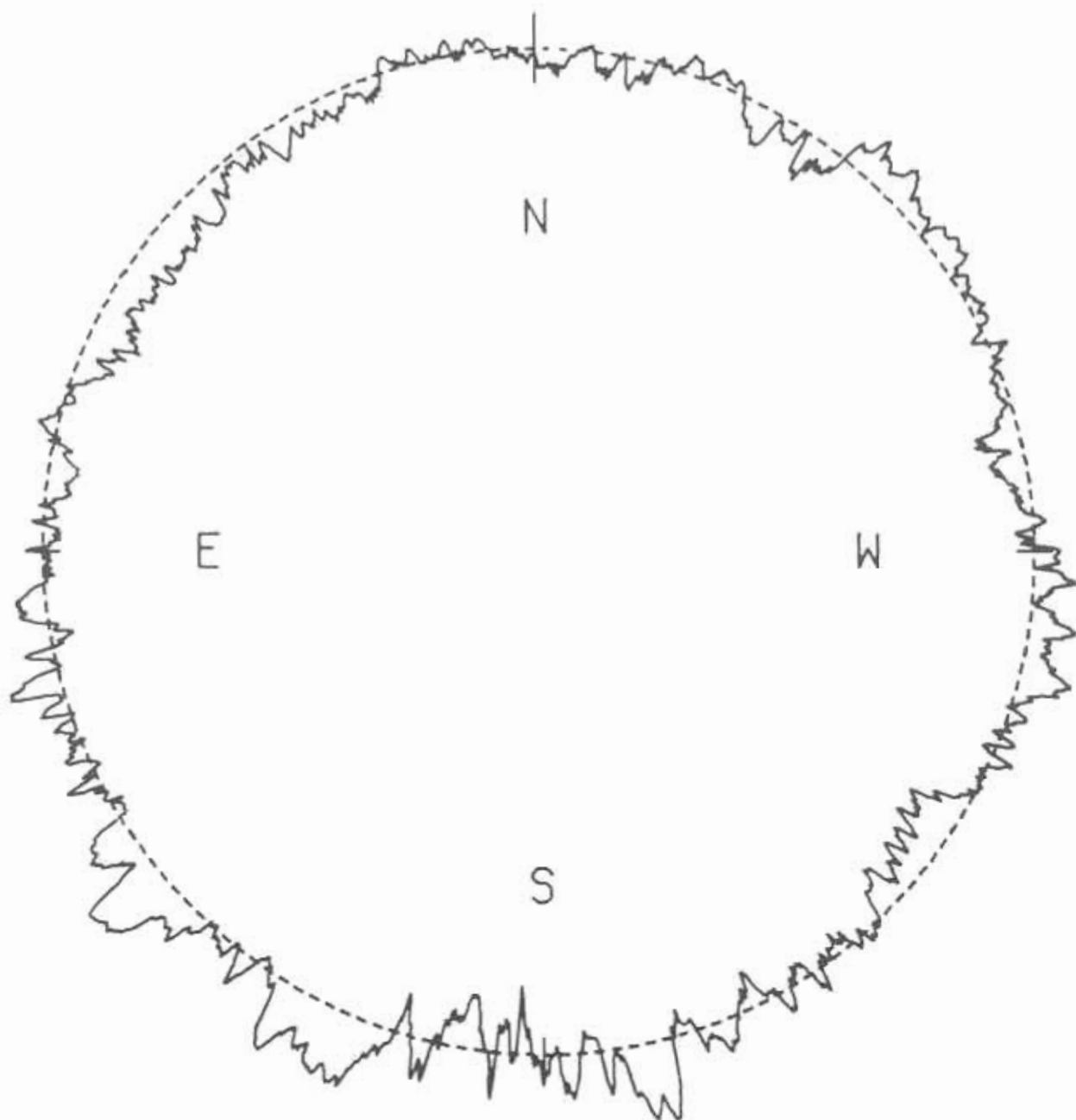

LUNAR LIMB PROFILE

13

L=+4°00 B=0°00

RADIAL SCALE: 1 SECOND OF ARC = \longleftarrow
DOTTED LINE = MEAN LIMB SOLID LINE = TRUE LIMB

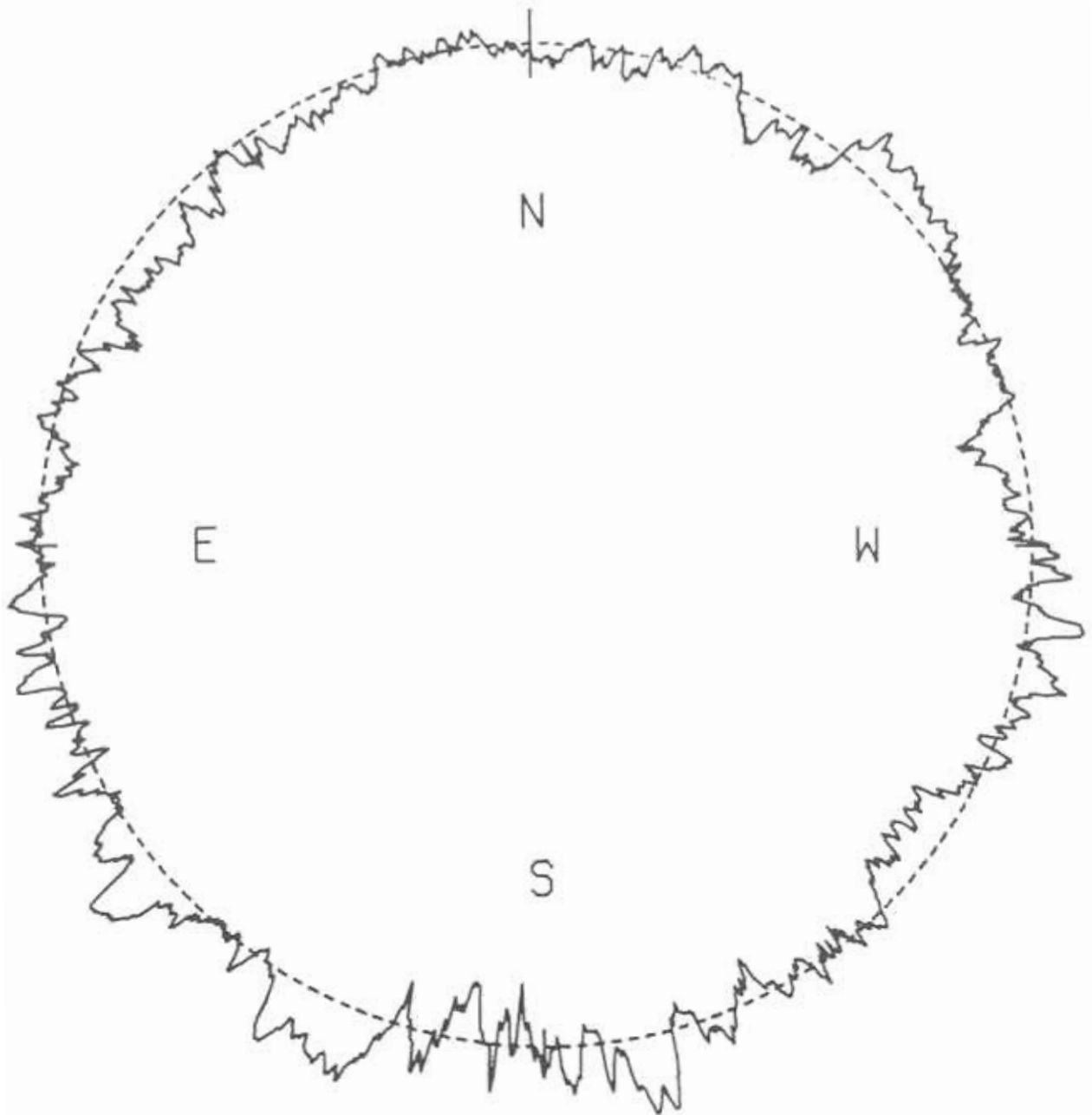

LUNAR LIMB PROFILE

15

L=+3°00 B=0°00

RADIAL SCALE: 1 SECOND OF ARC = \dashv
DOTTED LINE = MEAN LIMB SOLID LINE = TRUE LIMB

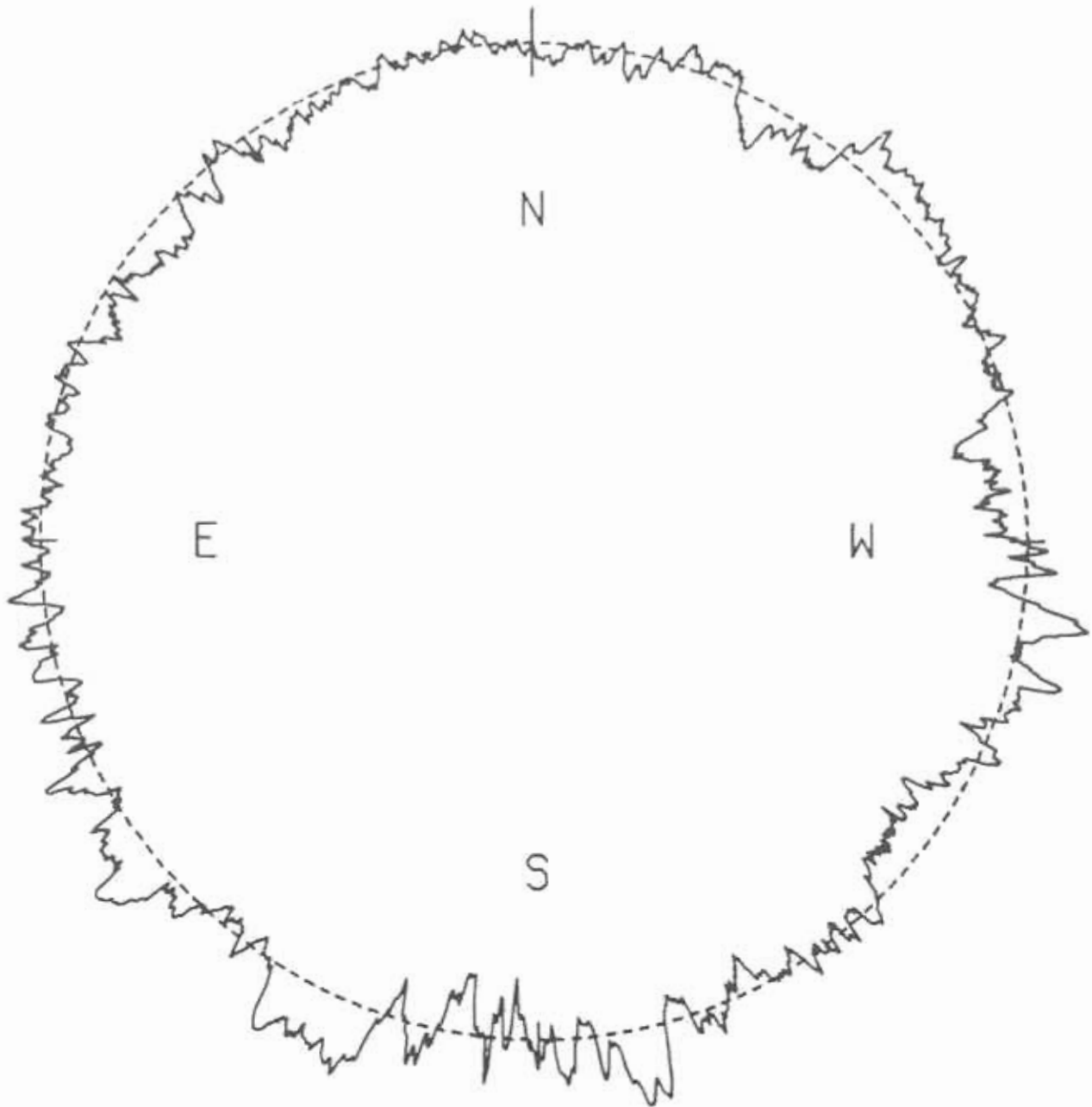

LUNAR LIMB PROFILE

17

L=+2°00 B=0°00

RADIAL SCALE: 1 SECOND OF ARC = ---
DOTTED LINE = MEAN LIMB SOLID LINE = TRUE LIMB

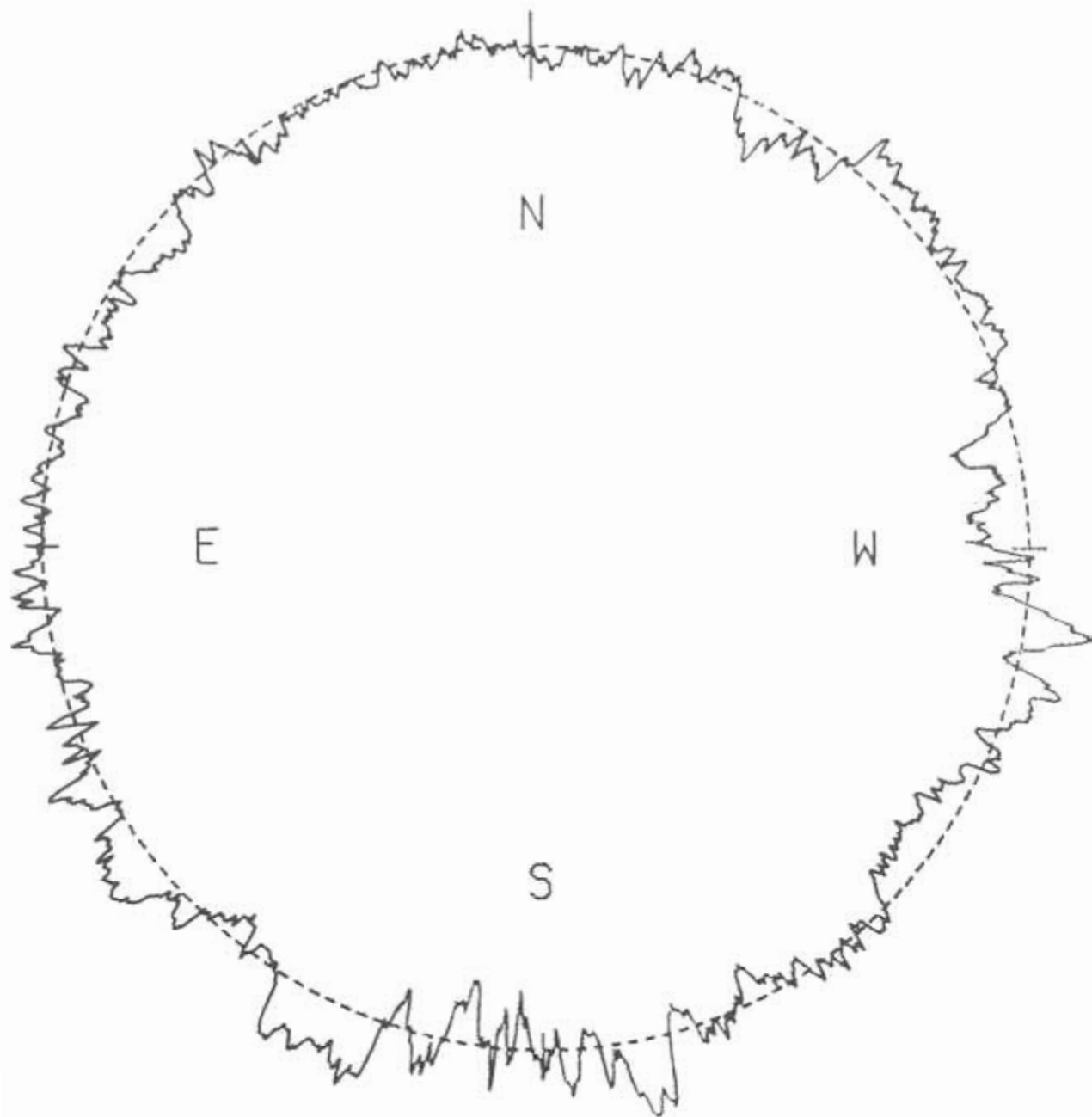

LUNAR LIMB PROFILE

L=+1°00 B=0°00

RADIAL SCALE: 1 SECOND OF ARC = 
DOTTED LINE = MEAN LIMB SOLID LINE = TRUE LIMB

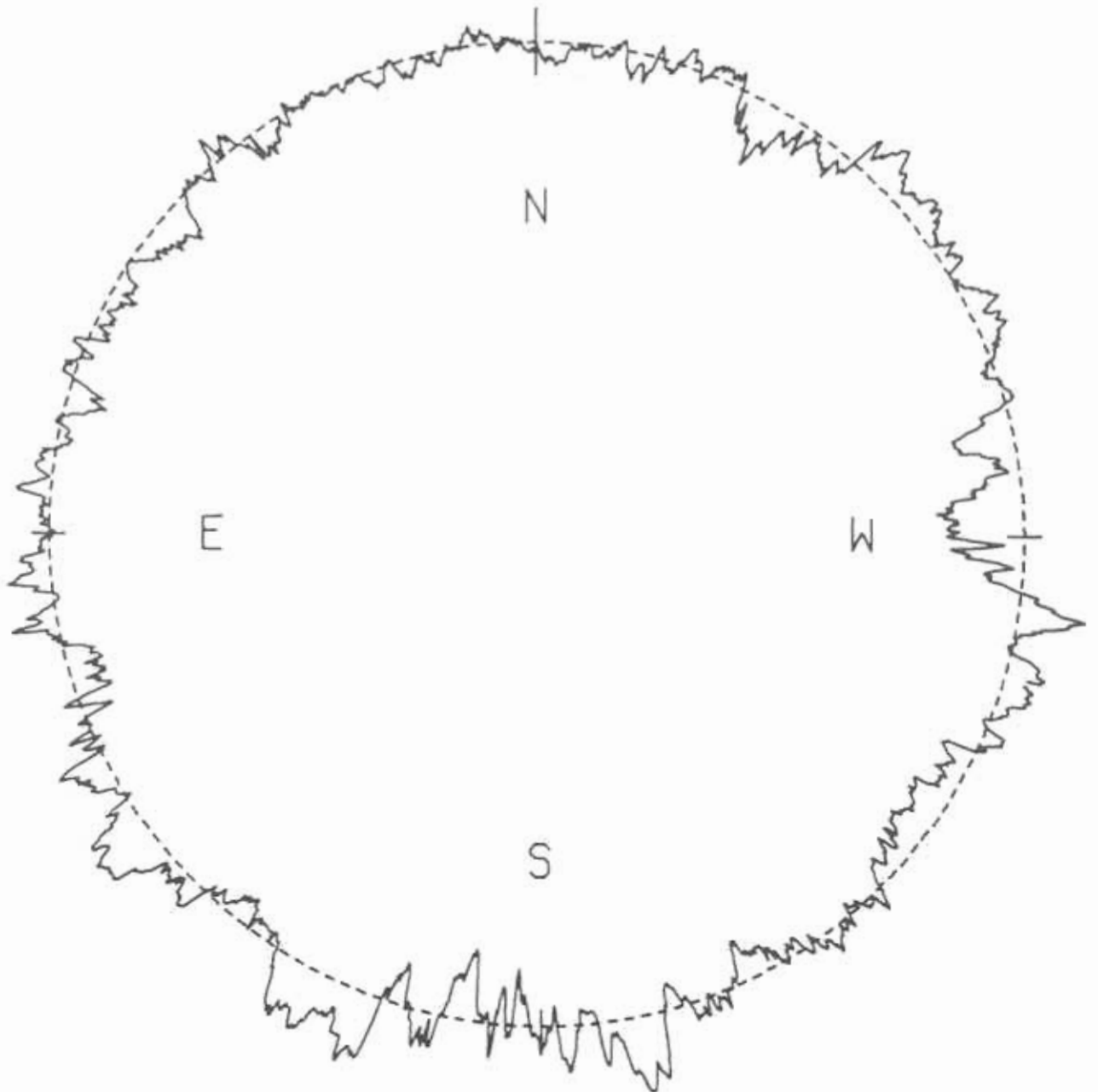

LUNAR LIMB PROFILE

L=0°00

B=0°00

RADIAL SCALE: 1 SECOND OF ARC = ---
DOTTED LINE = MEAN LIMB SOLID LINE = TRUE LIMB

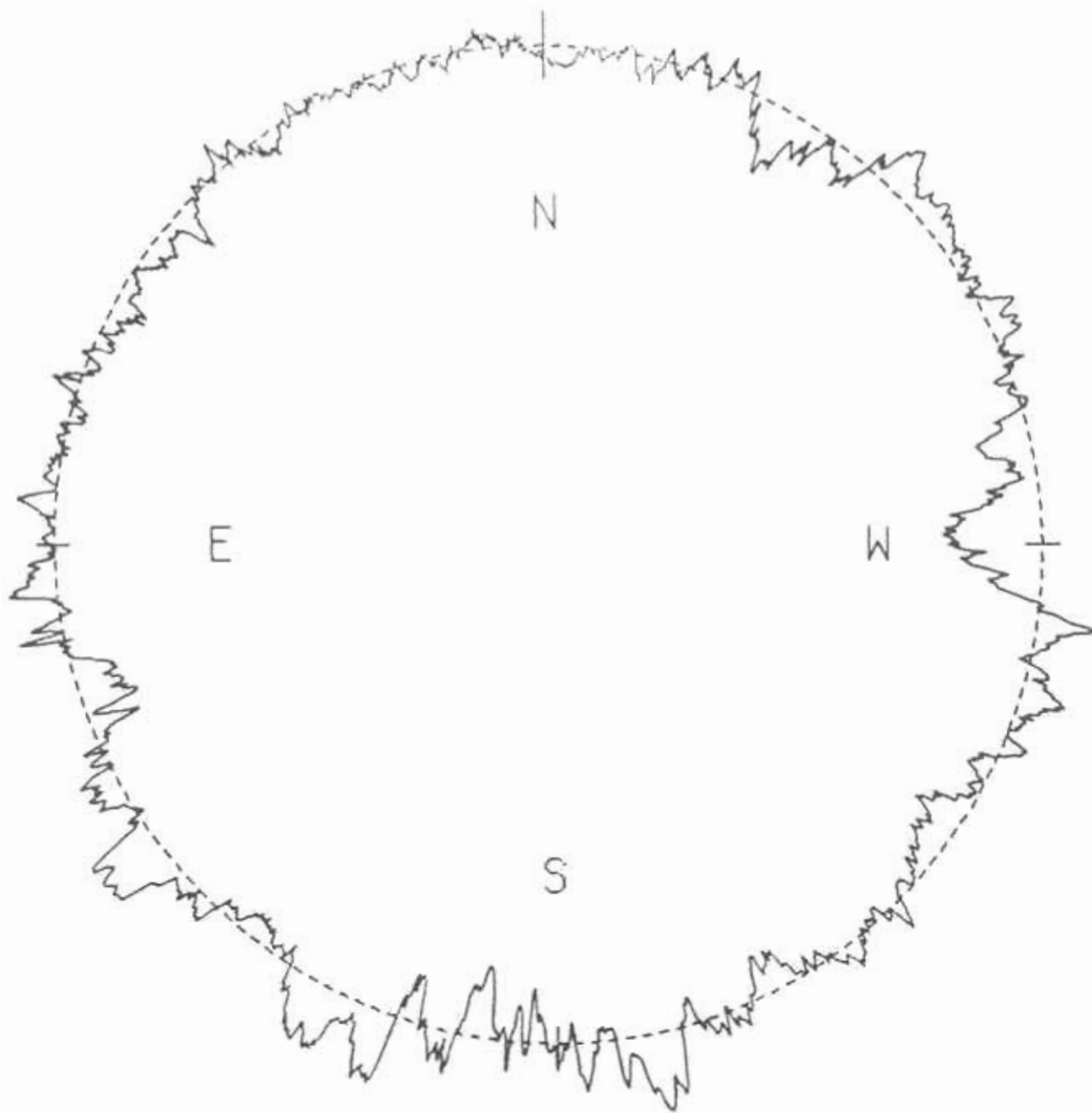

LUNAR LIMB PROFILE

L=-1°00 B=0°00

RADIAL SCALE: 1 SECOND OF ARC = 
DOTTED LINE = MEAN LIMB SOLID LINE = TRUE LIMB

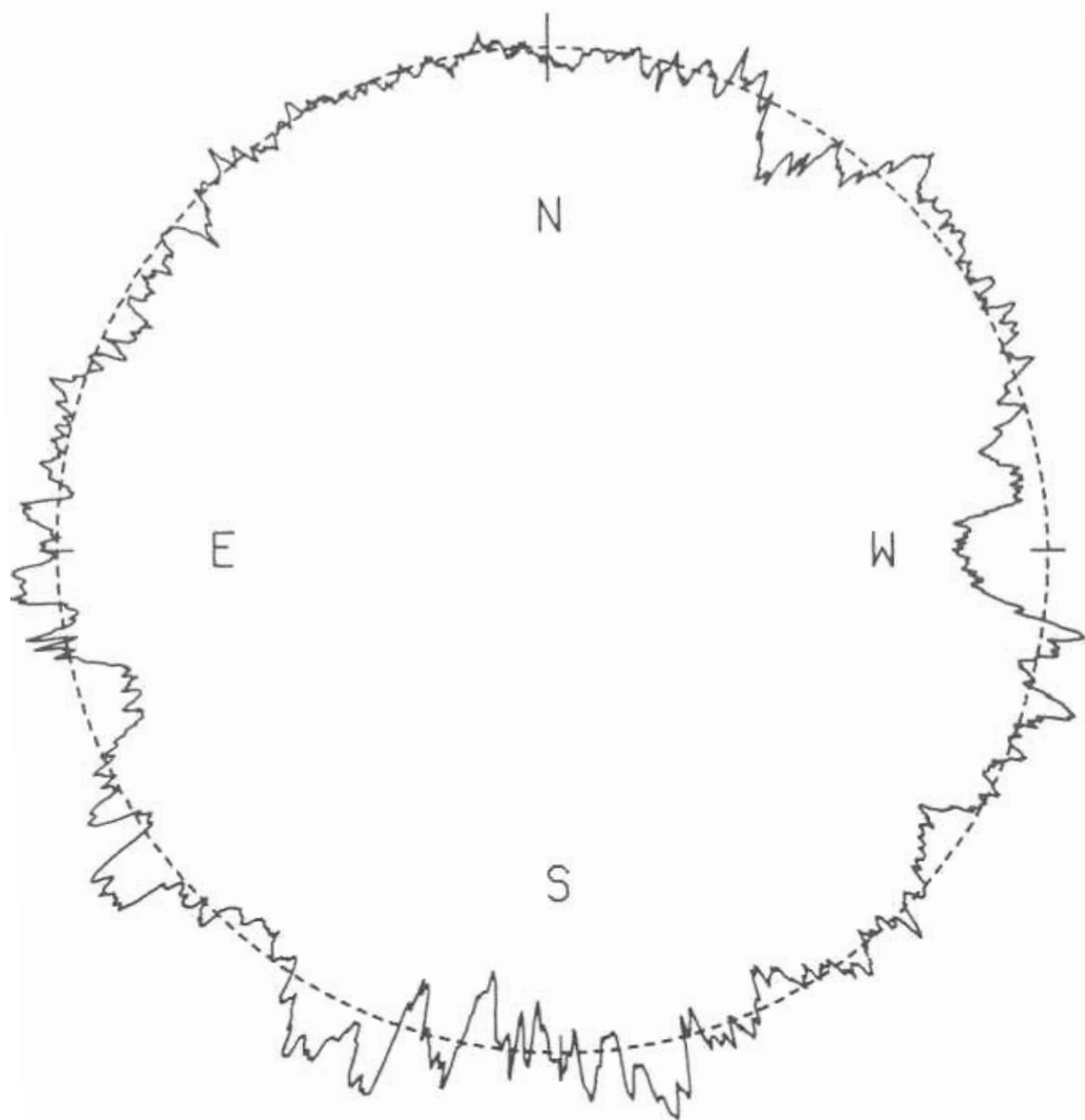

LUNAR LIMB PROFILE

L=-2°00 B=0°00

RADIAL SCALE: 1 SECOND OF ARC = \longleftrightarrow
DOTTED LINE = MEAN LIMB SOLID LINE = TRUE LIMB

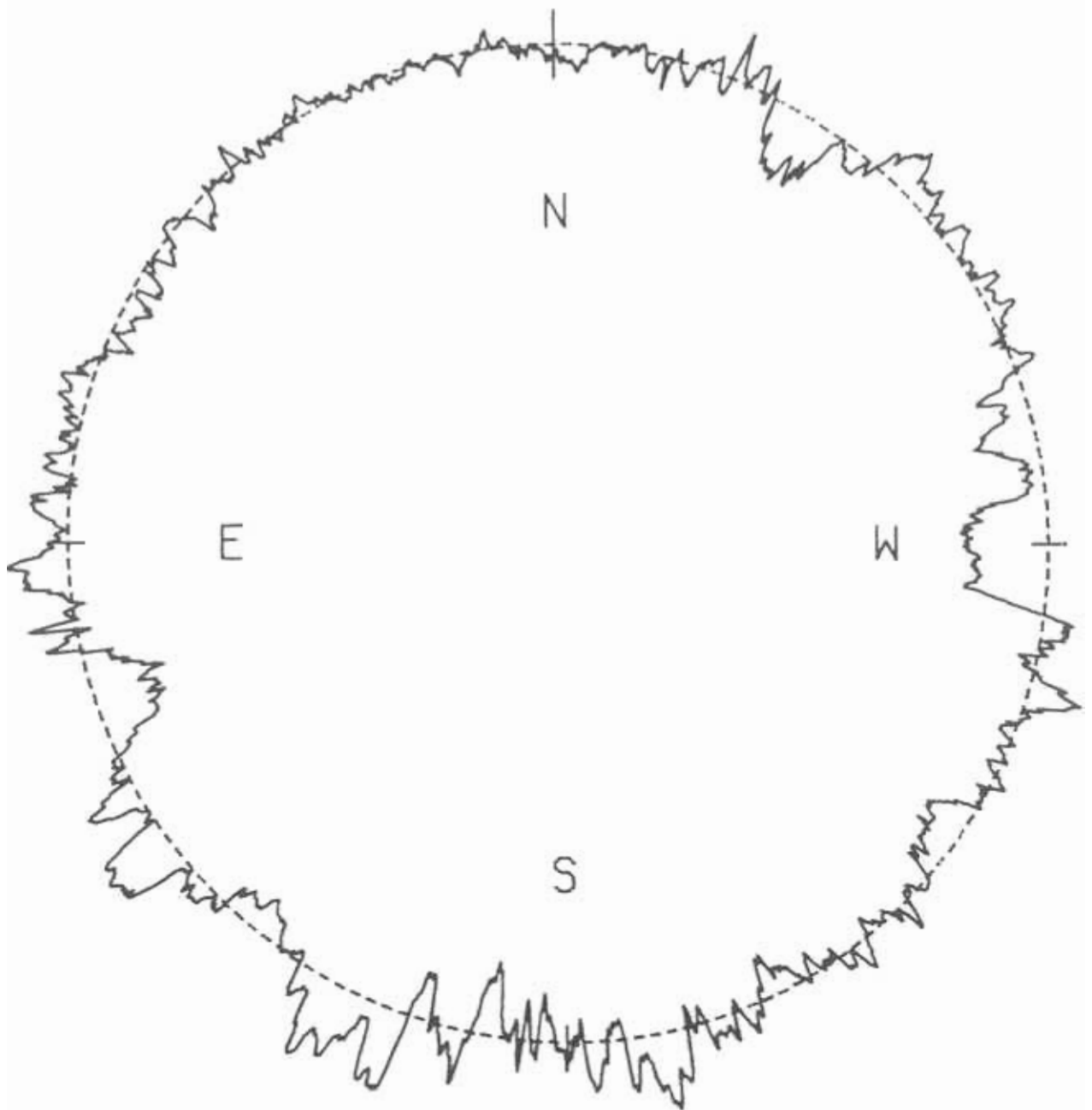

LUNAR LIMB PROFILE

L=-3°00 B=0°00

RADIAL SCALE: 1 SECOND OF ARC = ---
DOTTED LINE = MEAN LIMB SOLID LINE = TRUE LIMB

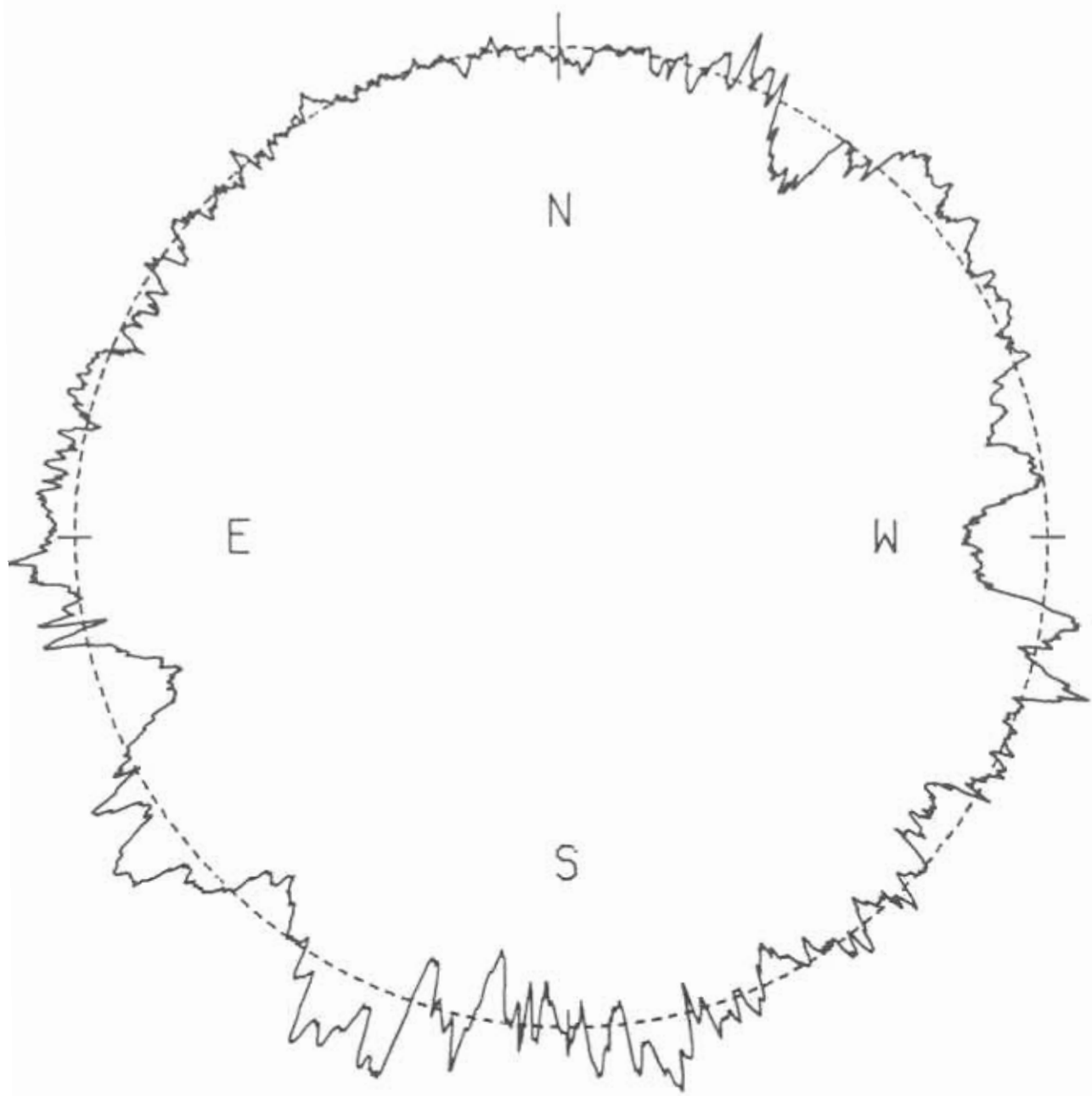

LUNAR LIMB PROFILE

29

L=-4°00 B=0°00

RADIAL SCALE: 1 SECOND OF ARC = \longleftarrow
DOTTED LINE = MEAN LIMB SOLID LINE = TRUE LIMB

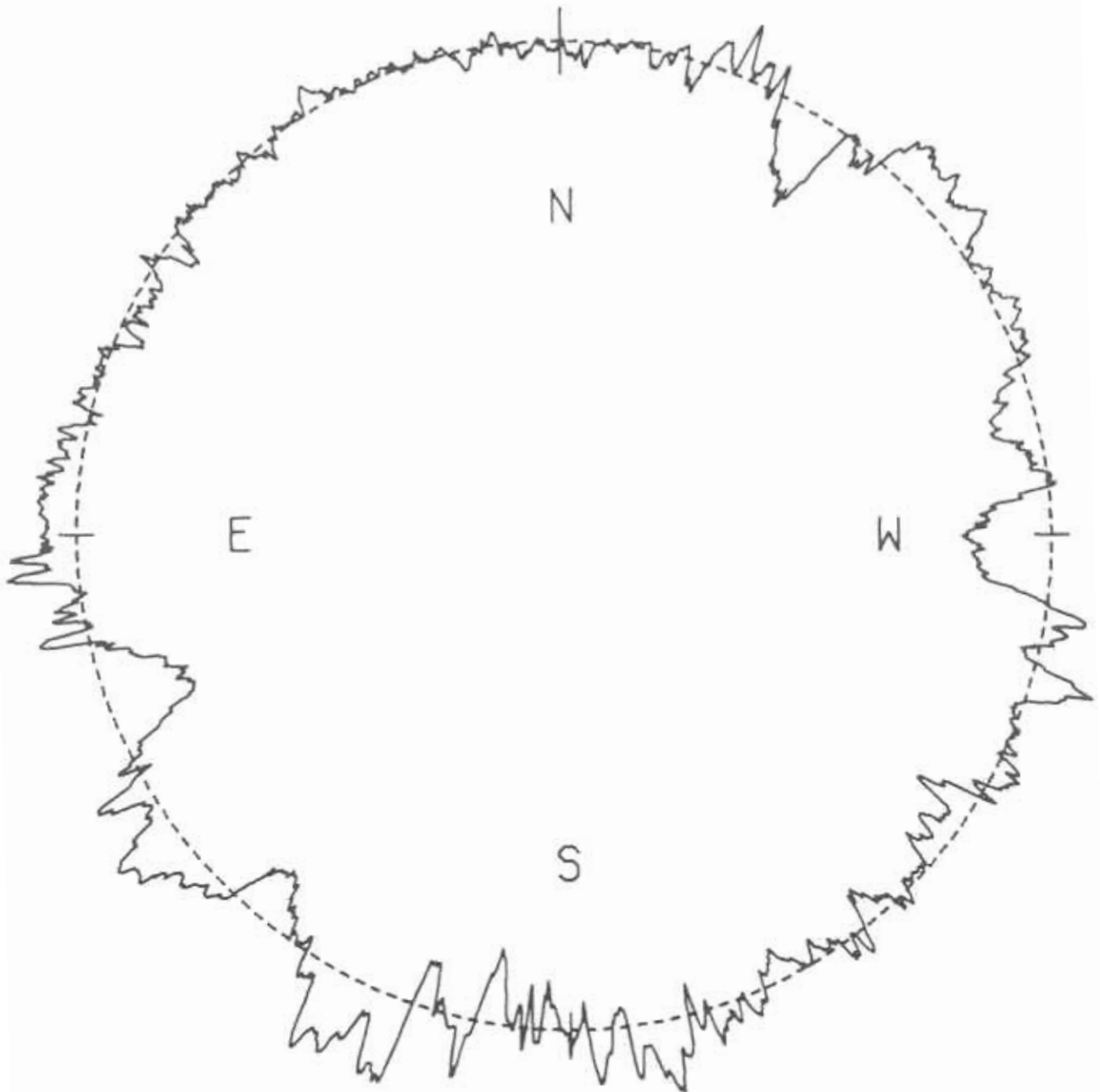

LUNAR LIMB PROFILE

31

L=-5°00 B=0°00

RADIAL SCALE: 1 SECOND OF ARC = ---
DOTTED LINE = MEAN LIMB SOLID LINE = TRUE LIMB

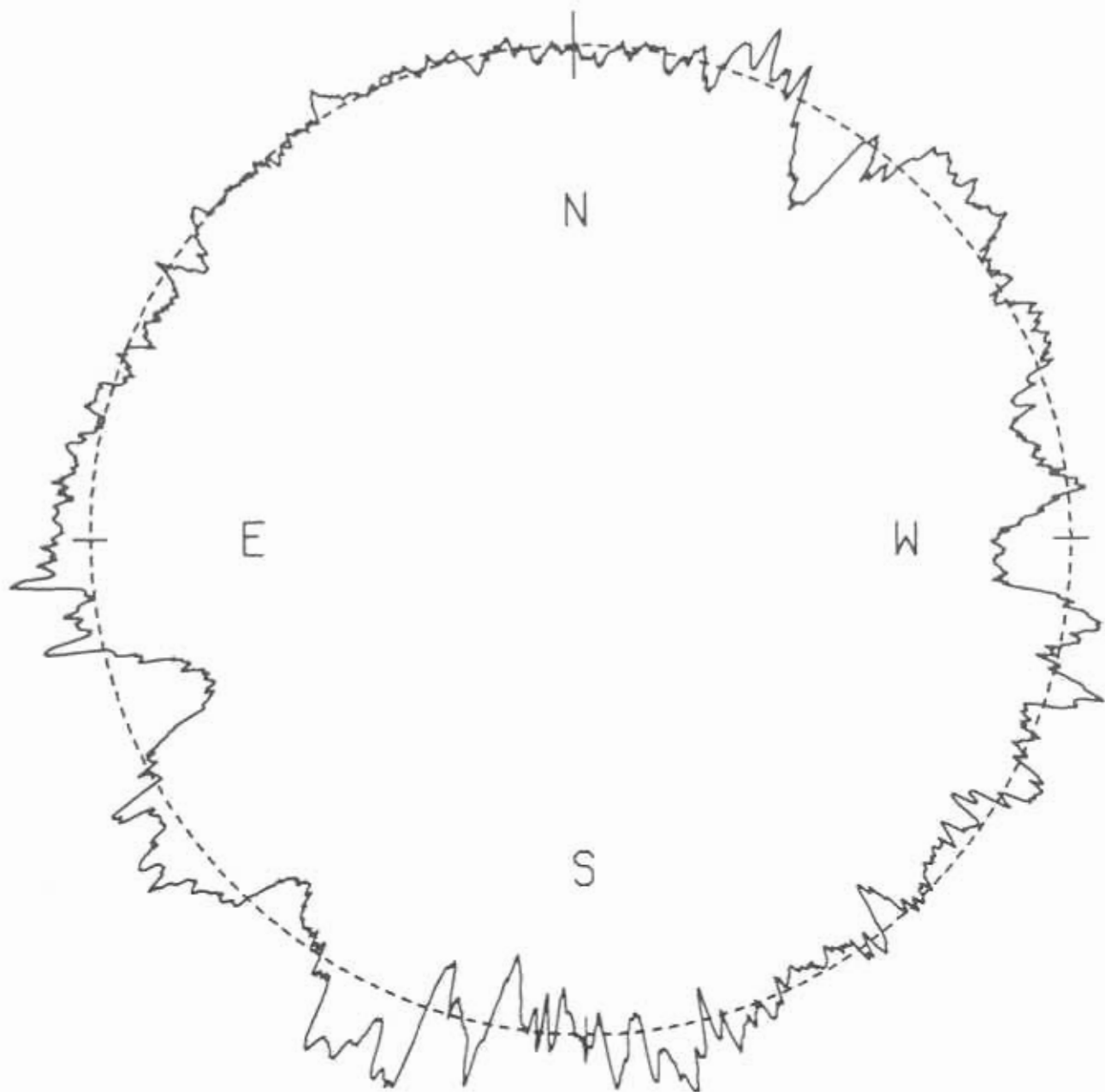

LUNAR LIMB PROFILE

L=-6°00 B=0°00

RADIAL SCALE: 1 SECOND OF ARC = 
DOTTED LINE = MEAN LIMB SOLID LINE = TRUE LIMB

